

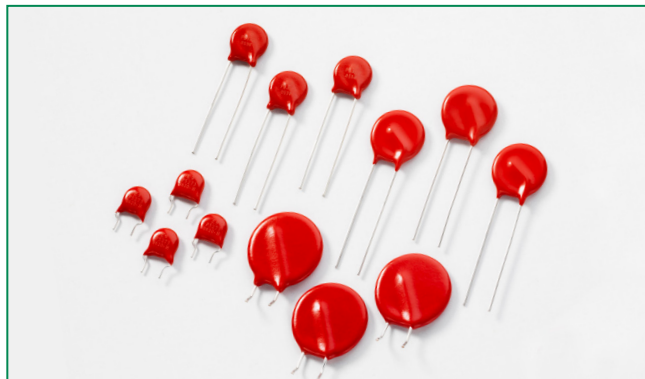





### UltraMOV® Varistor Series



#### Agency Approvals

| Agency  | Agency Approval  | Agency File Number                 |
|---|--|------------------------------------|
|    | UL1449   | E320116 <sup>3</sup>               |
|    | CECC 42201-006<br>IEC 61051-1<br>IEC 61051-2<br>IEC 60950-1 (Annex Q) for 14mm and 20mm only         | 116895 <sup>1</sup>                |
|   | CSA C22.2 No. 1  | 91788                              |
|  | CECC 42201-006<br>IEC 61051-1<br>IEC 61051-2<br>IEC 60950-1 (Annex Q) for 10mm, 14mm and 20mm only   | IECQ-C<br>BSI 14.0001 <sup>1</sup> |
|  | IEC/EN 61051-1<br>IEC 61051-2<br>IEC 61051-2-2<br>IEC 60950-1 (Annex Q) for 10mm, 14mm and 20mm only | J 50324242 <sup>2</sup>            |

Notes:

- Epoxy coated only.
- Phenolic coated only.
- All epoxy coated sizes are UL Recognized while only 10mm, 14mm, and 20mm phenolic coated parts are UL recognized.

#### Description

The UltraMOV® Metal Oxide Varistor Series is designed for applications requiring high peak surge current ratings and high energy absorption capability. UltraMOV® varistors are primarily intended for use in AC Line Voltage applications such as Surge Protection Device (SPD), Uninterruptable Power Supplies (UPS), AC Power Taps, AC Power Meters, or other products that require voltage clamping of high transient surge currents from sources such as lightning, inductive load switching, or capacitor bank switching.

These devices are produced in radial lead package sizes of 7, 10, 14 and 20mm and offered in a variety of lead forms. UltraMOV® varistor are manufactured with recognized epoxy encapsulation and are rated for ambient temperatures up to 85°C with no derating. This Series is LASER-branded and is supplied in bulk, ammo pack (fan-fold), or tape and reel packaging.

#### Features

- Lead-free, Halogen-Free and RoHS compliant
- High peak surge current rating ( $I_{TM}$ ) up to 10kA, single 8 x 20 pulse, (20mm)
- Standard operating voltage range compatible with common AC line voltages (130  $V_{AC}$  to 625  $V_{AC}$ )
- Characterized for maximum standby current (Leakage)
- Custom voltage types available
- Standard lead form and lead space options
- High operating temperature range up to 125°C (phenolic coating option). 10mm, 14mm and 20mm devices are UL Recognized and TUV certified with 800V isolation voltage rating

#### Absolute Maximum Ratings

- For ratings of individual members of a series, see Device Ratings and Specifications chart

| Continuous   | UltraMOV® Varistor Series | Units |
|--|---------------------------|-------|
| Steady State Applied Voltage:  |                           |       |
| AC Voltage Range ( $V_{MIAC,RMS}$ )  | 130 to 625                | V     |
| Transients:  |                           |       |
| Single-Pulse Peak Current ( $I_{TM}$ ) 8x20µs Wave (See Figure 2)                            | 1,750 to 10,000           | A     |
| Single-Pulse Energy Range ( $W_{TM}$ ) 2ms Square Wave                                       | 12.5 to 400               | J     |
| Operating Ambient Temperature Range ( $T_A$ ) for Epoxy coated                               | -55 to +85                | °C    |
| Operating Ambient Temperature Range ( $T_A$ ) for Phenolic coated                            | -55 to +125               | °C    |
| Storage Temperature Range ( $T_{STG}$ ) for Epoxy coated                                     | -55 to +125               | °C    |
| Storage Temperature Range ( $T_{STG}$ ) for Phenolic coated                                  | -55 to +150               | °C    |
| Temperature Coefficient ( $\alpha$ ) of Clamping Voltage ( $V_C$ ) at Specified Test Current | <0.01                     | %/°C  |
| Hi-Pot Encapsulation (COATING Isolation Voltage Capability)                                  | 2500                      | V     |
| COATING Insulation Resistance  | 1000                      | MΩ    |

CAUTION: Stresses above those listed in "Absolute Maximum Ratings" may cause permanent damage to the device. This is a stress only rating and operation of the device at these or any other conditions above those indicated in the operational sections of this specification is not implied.

### UltraMOV® Series Ratings & Specifications

| Epoxy Coated Models |          | Phenolic Coated Models |          | Maximum Rating (85°C) |                    |                 |                           |                           | Specifications (25°C)                   |       |                                   |     |                     |
|---------------------|----------|------------------------|----------|-----------------------|--------------------|-----------------|---------------------------|---------------------------|---|-------|-----------------------------------|-----|---------------------|
|                     |          |                        |          | Continuous            |                    | Transient       |                           |                           | Varistor Voltage at 1mA DC Test Current |       | Maximum Clamping Voltage 8 x 20µs |     | Typical Capacitance |
| Part Number         | Branding | Part Number            | Branding | RMS Volts             | DC Volts           | Energy 2ms      | Peak Current 8 x 20µs     |                           |   |       |                                   |     |                     |
|                     |          |                        |          | V <sub>M(AC)</sub>    | V <sub>M(DC)</sub> | W <sub>TM</sub> | I <sub>TM</sub> 1 x Pulse | I <sub>TM</sub> 2 x Pulse |   |       |                                   |     |                     |
|                     |          |                        |          | (V)                   | (V)                | (J)             | (A)                       | (A)                       | (V)                                     | (V)   | (V)                               | (A) | (pF)                |
| V07E130P            | P7V130   | V07P130P               | P7P130   | 130                   | 170                | 12.5            | 1750                      | 1200                      | 184.5                                   | 225.5 | 340                               | 10  | 180                 |
| V10E130P            | P10V130  | V10P130P               | P10P130  | 130                   | 170                | 25              | 3500                      | 2500                      | 184.5                                   | 225.5 | 340                               | 25  | 450                 |
| V14E130P            | P14V130  | V14P130P               | P14P130  | 130                   | 170                | 50              | 6000                      | 4500                      | 184.5                                   | 225.5 | 340                               | 50  | 1000                |
| V20E130P            | P20V130  | V20P130P               | P20P130  | 130                   | 170                | 100             | 10000                     | 6500                      | 184.5                                   | 225.5 | 340                               | 100 | 1900                |
| V07E140P            | P7V140   | V07P140P               | P7P140   | 140                   | 180                | 13.5            | 1750                      | 1200                      | 198                                     | 242   | 360                               | 10  | 160                 |
| V10E140P            | P10V140  | V10P140P               | P10P140  | 140                   | 180                | 27.5            | 3500                      | 2500                      | 198                                     | 242   | 360                               | 25  | 400                 |
| V14E140P            | P14V140  | V14P140P               | P14P140  | 140                   | 180                | 55              | 6000                      | 4500                      | 198                                     | 242   | 360                               | 50  | 900                 |
| V20E140P            | P20V140  | V20P140P               | P20P140  | 140                   | 180                | 110             | 10000                     | 6500                      | 198                                     | 242   | 360                               | 100 | 1750                |
| V07E150P            | P7V150   | V07P150P               | P7P150   | 150                   | 200                | 15              | 1750                      | 1200                      | 216                                     | 264   | 395                               | 10  | 150                 |
| V10E150P            | P10V150  | V10P150P               | P10P150  | 150                   | 200                | 30              | 3500                      | 2500                      | 216                                     | 264   | 395                               | 25  | 360                 |
| V14E150P            | P14V150  | V14P150P               | P14P150  | 150                   | 200                | 60              | 6000                      | 4500                      | 216                                     | 264   | 395                               | 50  | 800                 |
| V20E150P            | P20V150  | V20P150P               | P20P150  | 150                   | 200                | 120             | 10000                     | 6500                      | 216                                     | 264   | 395                               | 100 | 1600                |
| V07E175P            | P7V175   | V07P175P               | P7P175   | 175                   | 225                | 17              | 1750                      | 1200                      | 243                                     | 297   | 455                               | 10  | 130                 |
| V10E175P            | P10V175  | V10P175P               | P10P175  | 175                   | 225                | 35              | 3500                      | 2500                      | 243                                     | 297   | 455                               | 25  | 350                 |
| V14E175P            | P14V175  | V14P175P               | P14P175  | 175                   | 225                | 70              | 6000                      | 4500                      | 243                                     | 297   | 455                               | 50  | 700                 |
| V20E175P            | P20V175  | V20P175P               | P20P175  | 175                   | 225                | 135             | 10000                     | 6500                      | 243                                     | 297   | 455                               | 100 | 1400                |
| V07E230P            | P7V230   | V07P230P               | P7P230   | 230                   | 300                | 20              | 1750                      | 1200                      | 324                                     | 396   | 595                               | 10  | 100                 |
| V10E230P            | P10V230  | V10P230P               | P10P230  | 230                   | 300                | 42              | 3500                      | 2500                      | 324                                     | 396   | 595                               | 25  | 250                 |
| V14E230P            | P14V230  | V14P230P               | P14P230  | 230                   | 300                | 80              | 6000                      | 4500                      | 324                                     | 396   | 595                               | 50  | 550                 |
| V20E230P            | P20V230  | V20P230P               | P20P230  | 230                   | 300                | 160             | 10000                     | 6500                      | 324                                     | 396   | 595                               | 100 | 1100                |
| V07E250P            | P7V250   | V07P250P               | P7P250   | 250                   | 320                | 25              | 1750                      | 1200                      | 351                                     | 429   | 650                               | 10  | 90                  |
| V10E250P            | P10V250  | V10P250P               | P10P250  | 250                   | 320                | 50              | 3500                      | 2500                      | 351                                     | 429   | 650                               | 25  | 220                 |
| V14E250P            | P14V250  | V14P250P               | P14P250  | 250                   | 320                | 100             | 6000                      | 4500                      | 351                                     | 429   | 650                               | 50  | 500                 |
| V20E250P            | P20V250  | V20P250P               | P20P250  | 250                   | 320                | 170             | 10000                     | 6500                      | 351                                     | 429   | 650                               | 100 | 1000                |
| V07E275P            | P7V275   | V07P275P               | P7P275   | 275                   | 350                | 28              | 1750                      | 1200                      | 387                                     | 473   | 710                               | 10  | 80                  |
| V10E275P            | P10V275  | V10P275P               | P10P275  | 275                   | 350                | 55              | 3500                      | 2500                      | 387                                     | 473   | 710                               | 25  | 200                 |
| V14E275P            | P14V275  | V14P275P               | P14P275  | 275                   | 350                | 110             | 6000                      | 4500                      | 387                                     | 473   | 710                               | 50  | 450                 |
| V20E275P            | P20V275  | V20P275P               | P20P275  | 275                   | 350                | 190             | 10000                     | 6500                      | 387                                     | 473   | 710                               | 100 | 900                 |
| V07E300P            | P7V300   | V07P300P               | P7P300   | 300                   | 385                | 30              | 1750                      | 1200                      | 423                                     | 517   | 775                               | 10  | 70                  |
| V10E300P            | P10V300  | V10P300P               | P10P300  | 300                   | 385                | 60              | 3500                      | 2500                      | 423                                     | 517   | 775                               | 25  | 180                 |
| V14E300P            | P14V300  | V14P300P               | P14P300  | 300                   | 385                | 125             | 6000                      | 4500                      | 423                                     | 517   | 775                               | 50  | 400                 |
| V20E300P            | P20V300  | V20P300P               | P20P300  | 300                   | 385                | 250             | 10000                     | 6500                      | 423                                     | 517   | 775                               | 100 | 800                 |
| V07E320P            | P7V320   | V07P320P               | P7P320   | 320                   | 420                | 32              | 1750                      | 1200                      | 459                                     | 561   | 840                               | 10  | 65                  |
| V10E320P            | P10V320  | V10P320P               | P10P320  | 320                   | 420                | 67              | 3500                      | 2500                      | 459                                     | 561   | 840                               | 25  | 170                 |
| V14E320P            | P14V320  | V14P320P               | P14P320  | 320                   | 420                | 136             | 6000                      | 4500                      | 459                                     | 561   | 840                               | 50  | 380                 |
| V20E320P            | P20V320  | V20P320P               | P20P320  | 320                   | 420                | 273             | 10000                     | 6500                      | 459                                     | 561   | 840                               | 100 | 750                 |
| V07E385P            | P7V385   | V07P385P               | P7P385   | 385                   | 505                | 36              | 1750                      | 1200                      | 558                                     | 682   | 1025                              | 10  | 60                  |
| V10E385P            | P10V385  | V10P385P               | P10P385  | 385                   | 505                | 75              | 3500                      | 2500                      | 558                                     | 682   | 1025                              | 25  | 160                 |
| V14E385P            | P14V385  | V14P385P               | P14P385  | 385                   | 505                | 150             | 6000                      | 4500                      | 558                                     | 682   | 1025                              | 50  | 360                 |
| V20E385P            | P20V385  | V20P385P               | P20P385  | 385                   | 505                | 300             | 10000                     | 6500                      | 558                                     | 682   | 1025                              | 100 | 700                 |
| V07E420P            | P7V420   | V07P420P               | P7P420   | 420                   | 560                | 40              | 1750                      | 1200                      | 612                                     | 748   | 1120                              | 10  | 55                  |
| V10E420P            | P10V420  | V10P420P               | P10P420  | 420                   | 560                | 80              | 3500                      | 2500                      | 612                                     | 748   | 1120                              | 25  | 140                 |
| V14E420P            | P14V420  | V14P420P               | P14P420  | 420                   | 560                | 160             | 6000                      | 4500                      | 612                                     | 748   | 1120                              | 50  | 300                 |
| V20E420P            | P20V420  | V20P420P               | P20P420  | 420                   | 560                | 320             | 10000                     | 6500                      | 612                                     | 748   | 1120                              | 100 | 600                 |
| V07E440P            | P7V440   | V07P440P               | P7P440   | 440                   | 585                | 44              | 1750                      | 1200                      | 643.5                                   | 786.5 | 1180                              | 10  | 50                  |
| V10E440P            | P10V440  | V10P440P               | P10P440  | 440                   | 585                | 85              | 3500                      | 2500                      | 643.5                                   | 786.5 | 1180                              | 25  | 130                 |
| V14E440P            | P14V440  | V14P440P               | P14P440  | 440                   | 585                | 170             | 6000                      | 4500                      | 643.5                                   | 786.5 | 1180                              | 50  | 260                 |
| V20E440P            | P20V440  | V20P440P               | P20P440  | 440                   | 585                | 340             | 10000                     | 6500                      | 643.5                                   | 786.5 | 1180                              | 100 | 500                 |
| V07E460P            | P7V460   | V07P460P               | P7P460   | 460                   | 615                | 48              | 1750                      | 1200                      | 675                                     | 825   | 1240                              | 10  | 45                  |
| V10E460P            | P10V460  | V10P460P               | P10P460  | 460                   | 615                | 90              | 3500                      | 2500                      | 675                                     | 825   | 1240                              | 25  | 120                 |

**Ratings & Specifications (Continued...)**

| Epoxy Coated Models |          | Phenolic Coated Models |          | Maximum Rating (85°C) |                    |                 |                           |                           | Specifications (25°C)                   |                      |                                   |                 |                     |
|---------------------|----------|------------------------|----------|-----------------------|--------------------|-----------------|---------------------------|---------------------------|---|----------------------|-----------------------------------|-----------------|---------------------|
|                     |          |                        |          | Continuous            |                    | Transient       |                           |                           | Varistor Voltage at 1mA DC Test Current |                      | Maximum Clamping Voltage 8 x 20µs |                 | Typical Capacitance |
| Part Number         | Branding | Part Number            | Branding | RMS Volts             | DC Volts           | Energy 2ms      | Peak Current 8 x 20µs     |                           | V <sub>NOM</sub> Min                    | V <sub>NOM</sub> Max | V <sub>C</sub>                    | I <sub>PK</sub> | f = 1MHz            |
|                     |          |                        |          | V <sub>M(AC)</sub>    | V <sub>M(DC)</sub> | W <sub>TM</sub> | I <sub>TM</sub> 1 x Pulse | I <sub>TM</sub> 2 x Pulse |   |                      |                                   |                 |                     |
|                     |          |                        |          | (V)                   | (V)                | (J)             | (A)                       | (A)                       | (V)                                     |                      | (A)                               | (pF)            |                     |
| V14E460P            | P14V460  | V14P460P               | P14P460  | 460                   | 615                | 180             | 6000                      | 4500                      | 675                                     | 825                  | 1240                              | 50              | 220                 |
| V20E460P            | P20V460  | V20P460P               | P20P460  | 460                   | 615                | 360             | 10000                     | 6500                      | 675                                     | 825                  | 1240                              | 100             | 400                 |
| V07E510P            | P7V510   | V07P510P               | P7P510   | 510                   | 670                | 52              | 1750                      | 1200                      | 738                                     | 902                  | 1355                              | 10              | 40                  |
| V10E510P            | P10V510  | V10P510P               | P10P510  | 510                   | 670                | 92              | 3500                      | 2500                      | 738                                     | 902                  | 1355                              | 25              | 110                 |
| V14E510P            | P14V510  | V14P510P               | P14P510  | 510                   | 670                | 185             | 6000                      | 4500                      | 738                                     | 902                  | 1355                              | 50              | 200                 |
| V20E510P            | P20V510  | V20P510P               | P20P510  | 510                   | 670                | 365             | 10000                     | 6500                      | 738                                     | 902                  | 1355                              | 100             | 350                 |
| V10E550P            | P10V550  | V10P550P               | P10P550  | 550                   | 745                | 95              | 3500                      | 2500                      | 819                                     | 1001                 | 1500                              | 25              | 100                 |
| V14E550P            | P14V550  | V14P550P               | P14P550  | 550                   | 745                | 190             | 6000                      | 4500                      | 819                                     | 1001                 | 1500                              | 50              | 180                 |
| V20E550P            | P20V550  | V20P550P               | P20P550  | 550                   | 745                | 370             | 10000                     | 6500                      | 819                                     | 1001                 | 1500                              | 100             | 300                 |
| V10E625P            | P10V625  | V10P625P               | P10P625  | 625                   | 825                | 100             | 3500                      | 2500                      | 900                                     | 1100                 | 1650                              | 25              | 90                  |
| V14E625P            | P14V625  | V14P625P               | P14P625  | 625                   | 825                | 200             | 6000                      | 4500                      | 900                                     | 1100                 | 1650                              | 50              | 160                 |
| V20E625P            | P20V625  | V20P625P               | P20P625  | 625                   | 825                | 400             | 10000                     | 6500                      | 900                                     | 1100                 | 1650                              | 100             | 250                 |

NOTE: 1. Average power dissipation of transients should not exceed 0.25W, 0.4W, 0.6W and 1.0W for 7mm, 10mm, 14mm, and 20mm model sizes, respectively.

**Current Energy and Power Dissipation Ratings**

Should transients occur in rapid succession, the average power dissipation is the energy (watt-seconds) per pulse times the number of pulses per second. The power so developed must be within the specifications shown on the Device Ratings and Specifications Table for the specific

device. The operating values of a MOV need to be derated at high temperatures as shown above. Because varistors only dissipate a relatively small amount of average power they are not suitable for repetitive applications that involve substantial amounts of average power dissipation.

**Figure 1A - Power Derating for Epoxy Coated**

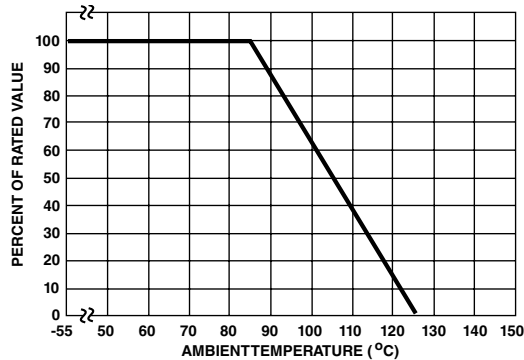

**Figure 1B - Power Derating for Phenolic Coated**

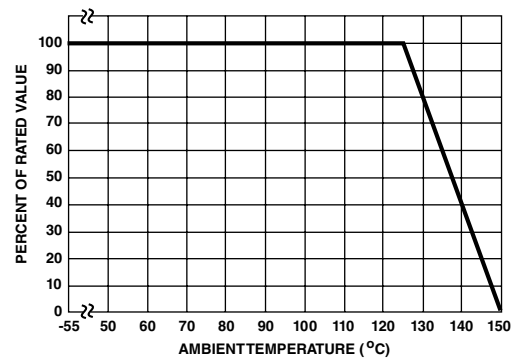

**Peak Pulse Current Test Waveform**

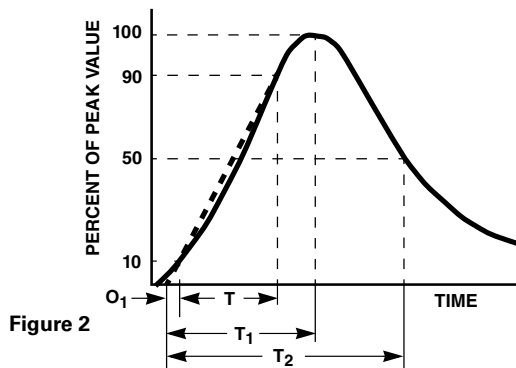

O<sub>1</sub> = Virtual Origin of Wave  
 T = Time from 10% to 90% of Peak  
 T<sub>1</sub> = Rise Time = 1.25 x T  
 T<sub>2</sub> = Decay Time  
**Example** - For an 8/20 µs Current Waveform:  
 8µs = T<sub>1</sub> = Rise Time  
 20µs = T<sub>2</sub> = Decay Time

**Transient V-I Characteristics Curves**

**Maximum Clamping Voltage for 7mm Parts**

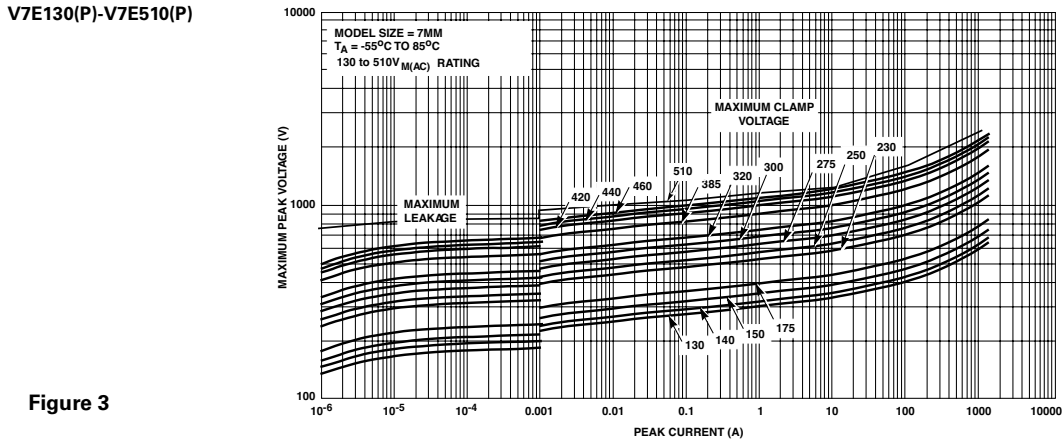

**Figure 3**

**Maximum Clamping Voltage for 10mm Parts**

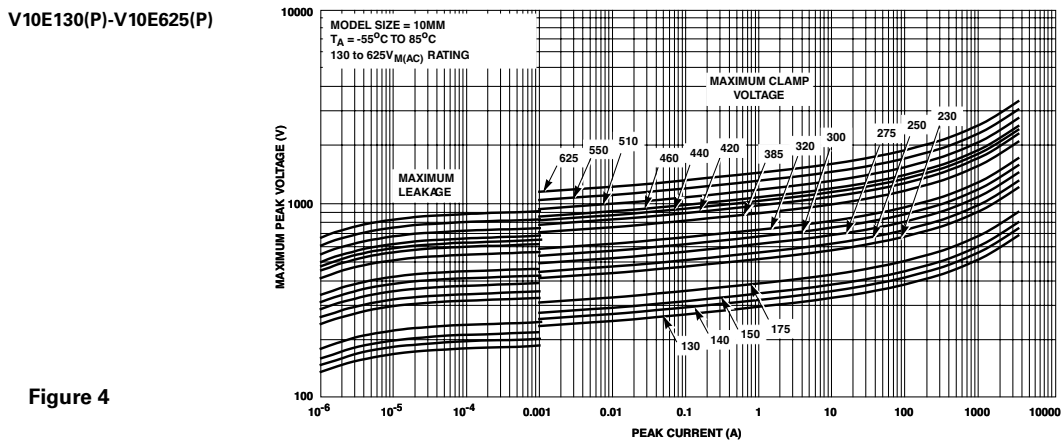

**Figure 4**

**Maximum Clamping Voltage for 14mm Parts**

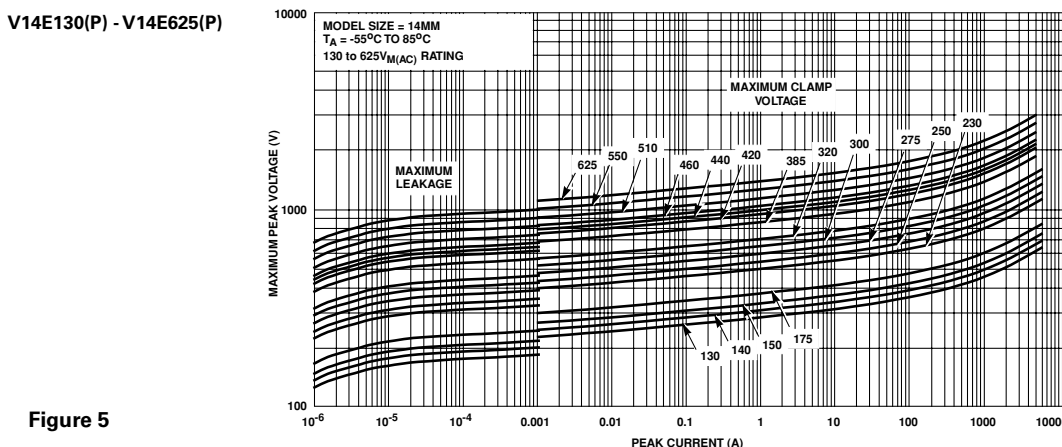
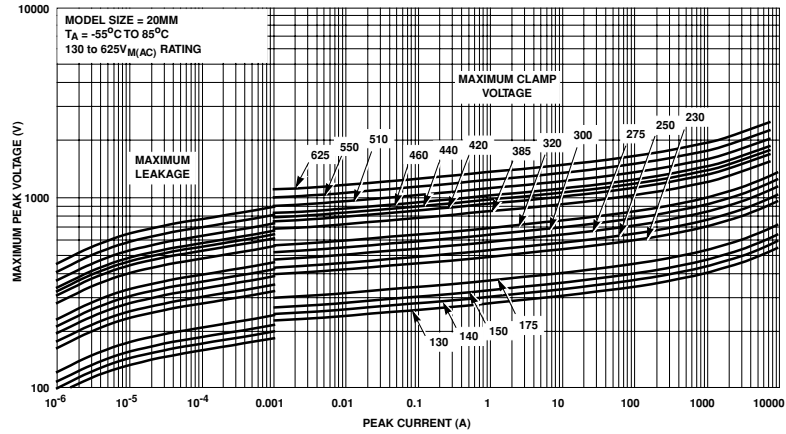

**Figure 5**

**Transient V-I Characteristics Curves**

**Maximum Clamping Voltage for 20mm Parts**

**V20E130(P) - V20E625(P)**

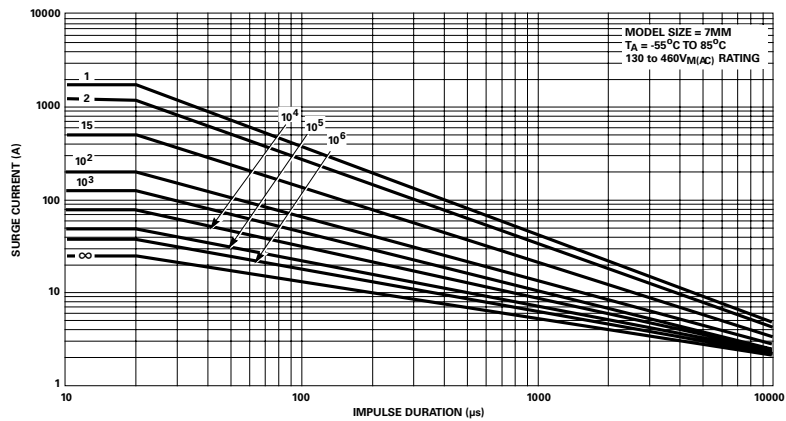

**Figure 6**

**Pulse Rating Curves**

**Repetitive Surge Capability for 7mm Parts**

**V7E130(P) - V7E460(P)**



**Figure 7**

**Additional Information**



**Datasheet**



**Resources**



**Samples**

**Pulse Rating Curves**

**Repetitive Surge Capability for 10mm Parts**

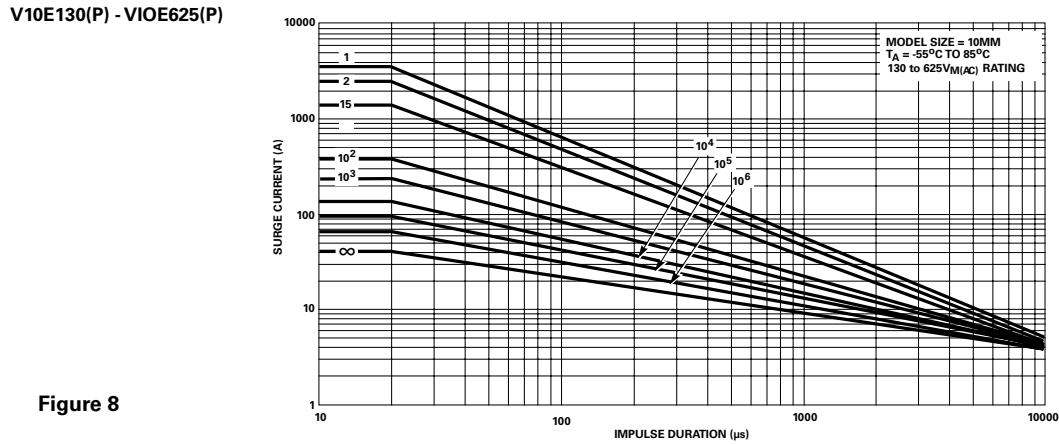

**Repetitive Surge Capability for 14mm Parts**

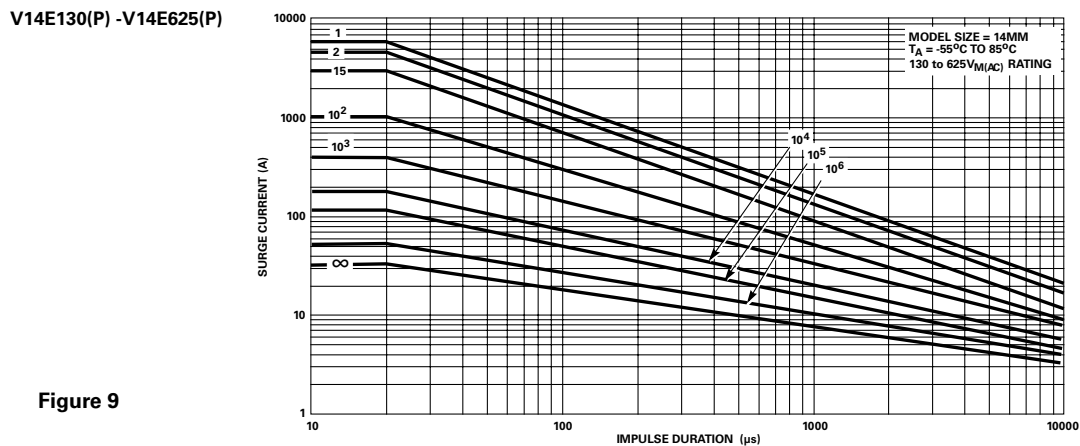

**Repetitive Surge Capability for 20mm Parts**

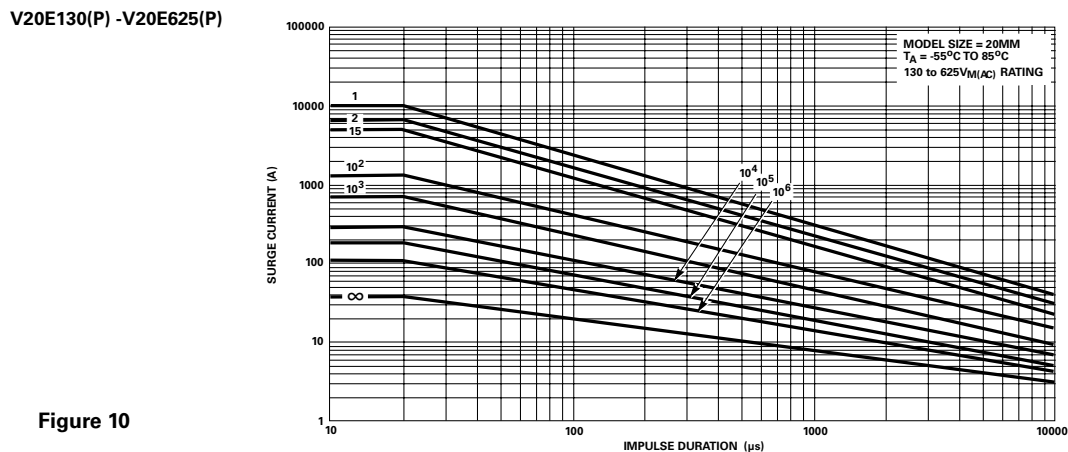

### Wave Solder Profile

#### Non Lead-free Profile

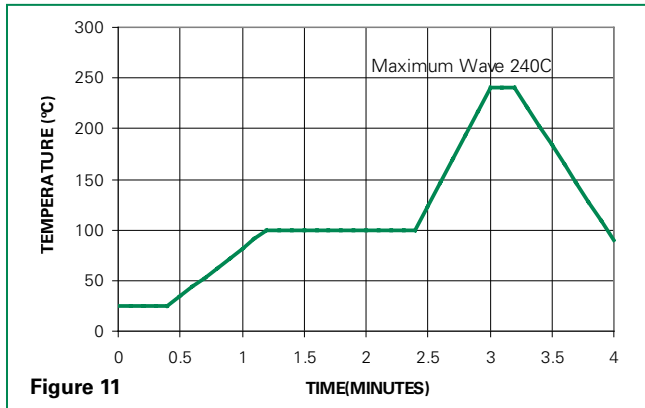

Figure 11

#### Lead-free Profile

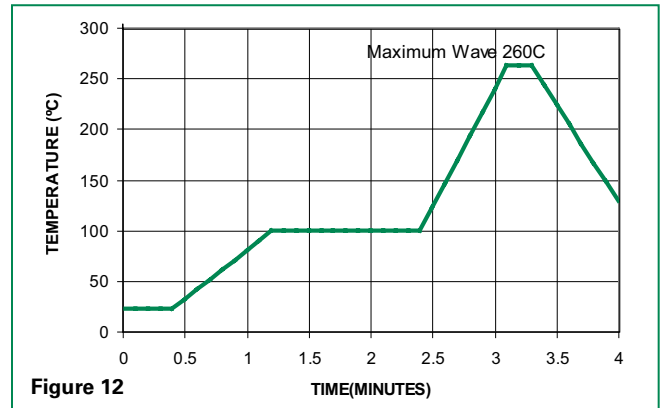

Figure 12

### Physical Specifications

|                                  |   |
|----------------------------------|---|
| <b>Lead Material</b>             | Copper Clad Steel Wire  |
| <b>Soldering Characteristics</b> | Solderability per MIL-STD-202, Method 208                       |
| <b>Insulating Material</b>       | Cured, flame retardant epoxy polymer meets UL94V-0 requirements |
| <b>Device Labeling</b>           | Marked with LF, voltage, UL/CSA logos, and date code            |

### Environmental Specifications

|                              |  |
|------------------------------|--|
| <b>Operating Temperature</b> | -55°C to +85°C   |
| <b>Storage Temperature</b>   | -55°C to +125°C  |
| <b>Humidity Aging</b>        | +85°C, 85% RH, 1000 hours<br>+/-10% typical voltage change |
| <b>Thermal Shock</b>         | +85°C to -40°C 5 times<br>+/-10% typical voltage change    |
| <b>Solvent Resistance</b>    | MIL-STD-202, Method 215                                    |
| <b>Moisture Sensitivity</b>  | Level 1, J-STD-020   |

### Phenolic Coating Option -- UltraMOV® Varistor Series for Hi-Temperature Operating Conditions:

- Phenolic Coated UltraMOV® Varistor Series devices are available with improved maximum operating temperature 125°C.
- These devices also have improved temperature cycling performance capability.
- Ratings and Specifications are as per standard UltraMOV® Series except Hi-Pot Encapsulation (Isolation Voltage Capability) = 800V.
- Phenolic Coating is HALOGEN FREE. To order: change 'E' (Epoxy coating) in part number to 'P' (Phenolic coating; e.g. V20P230)
- See Part Numbering System section of this series for more information.
- Contact factory for further details.
- Product marking:

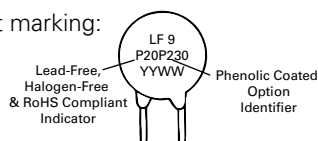

NOTE: 10mm, 14mm and 20mm devices are UL recognized and TUV certified with 800V isolation voltage rating.

### Product Dimensions (mm)

**Lead form options L1 and L3**  
(refer to table below)

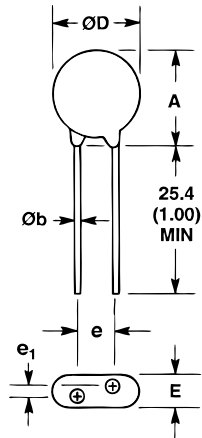

**Lead form options L2 and L4**  
(refer to table below)

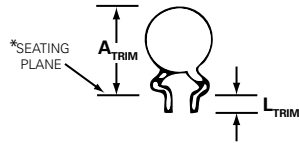

\*Seating plane interpretation per IEC-717  
(not available on tape or ammo pack)

| Dimension                     | V <sub>RMS</sub><br>Voltage<br>Model | 7mm Size         |                  | 10mm Size       |                 | 14mm Size       |                 | 20mm Size                |                          |
|-------------------------------|--------------------------------------|------------------|------------------|-----------------|-----------------|-----------------|-----------------|--------------------------|--------------------------|
|                               |                                      | Min.<br>mm (in)  | Max.<br>mm (in)  | Min.<br>mm (in) | Max.<br>mm (in) | Min.<br>mm (in) | Max.<br>mm (in) | Min.<br>mm (in)          | Max.<br>mm (in)          |
| <b>A</b>                      | 130-320                              | -                | 12 (0.472)       | -               | 16 (0.630)      | -               | 20 (0.787)      | -                        | 26.5 (1.043)             |
|                               | 385-625                              | -                | 13 (0.512)       | -               | 17 (0.689)      | -               | 20.5 (0.807)    | -                        | 28 (1.102)               |
| <b>ØD</b>                     | All                                  | -                | 9 (0.354)        | -               | 12.5 (0.492)    | -               | 17 (0.669)      | -                        | 23 (0.906)               |
| <b>e (Note 2)</b>             | All                                  | 4 (0.157)        | 6 (0.236)        | 6.5 (0.256)     | 8.5 (0.335)     | 6.5 (0.256)     | 8.5 (0.335)     | 9 (0.354)                | 11 (0.433)               |
| <b>e<sub>1</sub> (Note 3)</b> | 130-320                              | 1.5 (0.059)      | 3.5 (0.138)      | 1.5 (0.059)     | 3.5 (0.138)     | 1.5 (0.059)     | 3.5 (0.138)     | 1.5 (0.059)              | 3.5 (0.138)              |
|                               | 385-625                              | 2.5 (0.098)      | 5.5 (0.217)      | 2.5 (0.098)     | 5.5 (0.217)     | 2.5 (0.098)     | 5.5 (0.217)     | 2.5 (0.098)              | 5.5 (0.217)              |
| <b>E</b>                      | 130-320                              | -                | 5.6 (0.220)      | -               | 5.6 (0.220)     | -               | 5.6 (0.220)     | -                        | 5.6 (0.220)              |
|                               | 385-510                              | -                | 7.3 (0.287)      | -               | 7.3 (0.287)     | -               | 7.3 (0.287)     | -                        | 7.3 (0.287)              |
|                               | 550-625                              | -                | 8.3 (0.327)      | -               | 8.3 (0.327)     | -               | 8.3 (0.327)     | -                        | 8.3 (0.327)              |
| <b>Ø b</b>                    | All                                  | 0.585<br>(0.023) | 0.685<br>(0.027) | 0.76 (0.030)    | 0.86 (0.034)    | 0.76 (0.030)    | 0.86 (0.034)    | 0.76 (0.030)<br>(Note 2) | 0.86 (0.034)<br>(Note 2) |
| <b>A<sub>TRIM</sub></b>       | All                                  | -                | 15 (0.591)       | -               | 19.5 (0.768)    | -               | 22.5 (0.886)    | -                        | 29.0 (1.142)             |
| <b>L (L2)</b>                 | All                                  | 25.4 (1.00)      | -                | 25.4 (1.00)     | -               | 25.4 (1.00)     | -               | 25.4 (1.00)              | -                        |
| <b>*L (L4)</b>                | All                                  | 2.41 (0.095)     | 4.69 (0.185)     | 2.41 (0.095)    | 4.69 (0.185)    | 2.41 (0.095)    | 4.69 (0.185)    | 2.41 (0.095)             | 4.69 (0.185)             |

**NOTES:**

1. Measurements displayed in Millimeters (Inches in parentheses).
2. Standard lead space.
3. For in-line lead option L3, dimension e<sub>1</sub> is "zero". Straight lead form option L1 shown.

For information about bulk packaging quantities, please refer to the Ordering Notes section at the end of this document.



**Tape Specifications for Reel and Ammo Pack Items** (Refer to dimensions on following page)

**7mm Devices**

CRIMPED LEADS "L2"

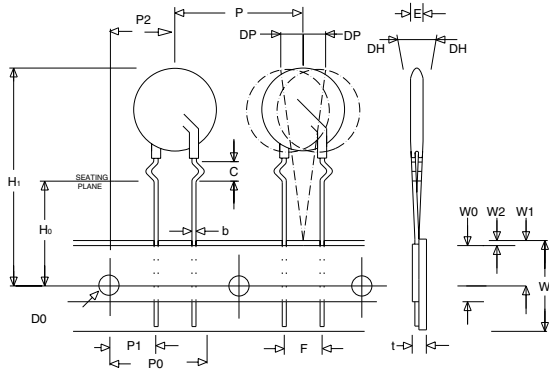

INLINE LEADS "L3"

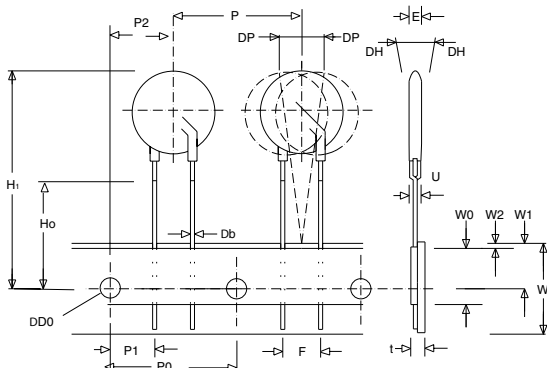

STRAIGHT LEADS "L1"

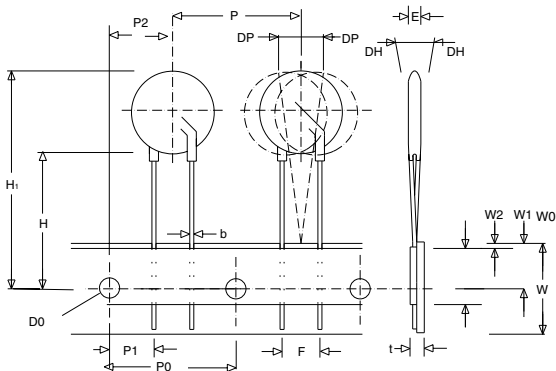

**10, 14 and 20mm Devices**

CRIMPED LEADS "L2"

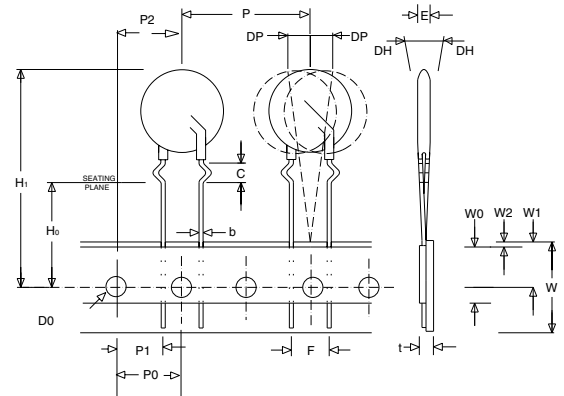

INLINE LEADS "L3"

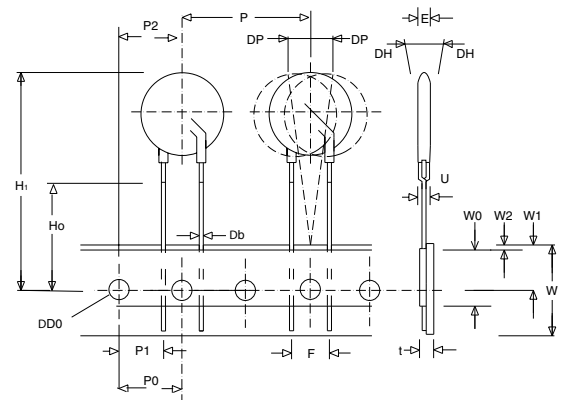

STRAIGHT LEADS "L1"

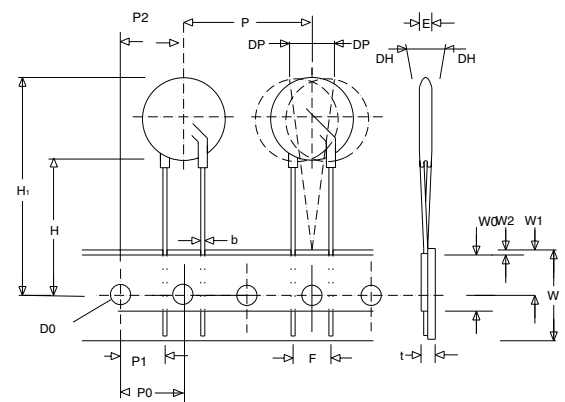

### Tape Specifications for Reel and Ammo Pack Items (Refer to drawings on previous page)

- Conforms to ANSI and EIA specifications.
- Can be supplied to IEC Publication 286-2.
- Radial devices on tape are offered with crimped leads, straight leads, or in-line leads. See Ordering Information.
- For 10mm devices 'P' (component pitch) is 12.7mm when 'F' (lead space) is 5mm.
- 7mm parts are available on tape and reel up to 460 VAC only
- 10mm parts are available on tape and reel up to 510 VAC only
- 14mm and 20mm parts are available on tape and reel up to 550 VAC only
- 7mm devices with 7.5mm lead spacing option will be taped at 25.4mm component pitch and 500 pieces per reel
- 10mm devices with 5.0mm lead spacing option will be taped at 12.7mm component pitch and 1000 pieces per reel

| Symbol               | Description                               | Model Size        |                    |                  |                   |
|----------------------|---|-------------------|--------------------|------------------|-------------------|
|                      |   | 7mm               | 10mm               | 14mm             | 20mm              |
| <b>B<sub>1</sub></b> | Component Top to Seating Plane            | 15 Max            | 19.5 Max           | 22.5 Max         | 29 Max            |
| <b>C</b>             | Crimp Length                              | 2.4 Typ           | 2.6 Typ            | 2.6 Typ          | 2.6 Typ           |
| <b>P</b>             | Pitch of Component                        | 12.7 +/- 1.0      | 25.4 +/- 1.0       | 25.4 +/- 1.0     | 25.4 +/- 1.0      |
| <b>P<sub>0</sub></b> | Feed Hole Pitch                           | 12.7 +/- 0.2      | 12.7 +/- 0.2       | 12.7 +/- 0.2     | 12.7 +/- 0.2      |
| <b>P<sub>1</sub></b> | Feed Hole Center to Pitch                 | 3.85 +/- 0.7      | 8.85 +/- 0.7       | 8.85 +/- 0.7     | 7.70 +/- 0.7      |
| <b>P<sub>2</sub></b> | Hole Center to Component Center           | 6.35 +/- 0.7      | 12.7 +/- 0.7       | 12.7 +/- 0.7     | 12.7 +/- 0.7      |
| <b>F</b>             | Lead to Lead Distance                     | 5.0 +/- 0.8       | 7.5 +/- 0.8        | 7.5 +/- 0.8      | 10.0 +/- 0.8      |
| <b>Δh</b>            | Component Alignment                       | 2.0 Max           | 2.0 Max            | 2.0 Max          | 2.0 Max           |
| <b>W</b>             | Tape Width                                | 18.0 +1.0 / -0.5  | 18.0 +1.0 / -0.52  | 18.0 +1.0 / -0.5 | 18.0 +1.0 / -0.5  |
| <b>W<sub>0</sub></b> | Hold Down Tape Width                      | 12.0 +/- 0.3      | 12.0 +/- 0.3       | 12.0 +/- 0.3     | 12.0 +/- 0.3      |
| <b>W<sub>1</sub></b> | Hole Position                             | 9.0 +0.75 / -0.50 | 9.0 +0.75 / - 0.50 | 9.0 +0.75 / 0.50 | 9.0 +0.75 / -0.50 |
| <b>W<sub>2</sub></b> | Hold Down Tape Position                   | 0.5 Max           | 0.5 Max            | 0.5 Max          | 0.5 Max           |
| <b>H</b>             | Height from Tape Center to Component Base | 18.0 +2.0 / -0.0  | 18.0 +2.0 / -0.0   | 18.0 +2.0 / -0.0 | 18.0 +2.0 / -0.0  |
| <b>H<sub>0</sub></b> | Seating Plane Height                      | 16.0 +/- 0.5      | 16.0 +/- 0.5       | 16.0 +/- 0.5     | 16.0 +/- 0.5      |
| <b>H<sub>1</sub></b> | Component Height                          | 32.0 Max          | 36.0 Max           | 40.0 Max         | 46.5 Max          |
| <b>D<sub>0</sub></b> | Feed Hole Diameter                        | 4.0 +/- 0.2       | 4.0 +/- 0.2        | 4.0 +/- 0.2      | 4.0 +/- 0.2       |
| <b>t</b>             | Total Tape Thickness                      | 0.7 +/- 0.2       | 0.7 +/- 0.2        | 0.7 +/- 0.2      | 0.7 +/- 0.2       |
| <b>Δp</b>            | Component Alignment                       | 3° Max, 1.00mm    | 3° Max, 1.00mm     | 3° Max, 1.00mm   | 3° Max, 1.00mm    |

For information on tape and reel packaging quantities, please refer to the Ordering Notes section at the end of this document.

**Disclaimer Notice - Information furnished is believed to be accurate and reliable. However, users should independently evaluate the suitability of and test each product selected for their own applications. Littelfuse products are not designed for, and may not be used in, all applications. Read complete Disclaimer Notice at [www.littelfuse.com/disclaimer-electronics](http://www.littelfuse.com/disclaimer-electronics).**

### Part Numbering System

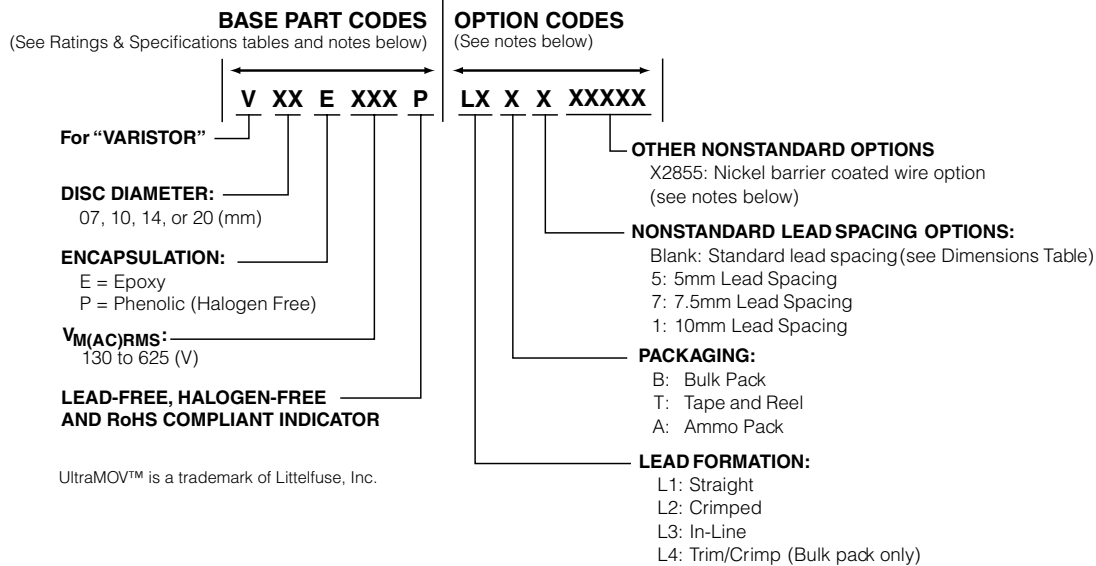

### Ordering Notes:

For standard parts, use the **BASE PART** designator only.

For parts with non-standard options (such as additional form, packaging and lead space options) use, **BASE PART + OPTION CODE**.

**OPTION CODE** items are subject to availability and minimum order requirements. Please contact a Littelfuse representative if you require additional information

#### OPTION CODES:

**X2855:** Nickel Barrier COATED WIRE OPTION

All standard parts use tinned copper clad steel wire. Nickel Barrier Coated Wire is available as an option, consisting of Copper Wire with a flashing of Nickel followed by a top coating of Tin.

**To order:** append standard model **BASE PART** number with "X2855." Example:

| Standard Model | Order As      |
|----------------|---------------|
| V18ZA40P       | V18ZA40PX2855 |

#### PACKAGING:

Littelfuse UltraMOV® varistors are shipped standard in bulk pack with straight leads and lead spacing outlined in the dimensions sections of this document. Contact a Littelfuse representative to discuss non-standard options.

#### Standard Part Default Conditions

| Device Size | Part # | Lead Space | Packaging |
|-------------|--------|------------|-----------|
| 7mm         | V07E-  | 5.0-/±1    | Bulk      |
| 10mm        | V10E-  | 7.5-/±1    | Bulk      |
| 14mm        | V14E-  | 7.5-/±1    | Bulk      |
| 20mm        | V20E-  | 10.0-/±1   | Bulk      |

#### Standard Bulk Pack Quantity

| Varistor Voltage | Standard Bulk Pack Quantity |      |      |      |
|------------------|-----------------------------|------|------|------|
|                  | Varistor Model Size         |      |      |      |
|                  | 7mm                         | 10mm | 14mm | 20mm |
| 130 – 275        | 1500                        | 1000 | 700  | 500  |
| 300 – 460        | 1500                        | 700  | 600  | 400  |
| 510 – 625        | 1500                        | 700  | 500  | 400  |

#### Tape & Reel Quantity

| Varistor Voltage | Shipping Quantity Per Reel |      |      |      |
|------------------|----------------------------|------|------|------|
|                  | 7mm                        | 10mm | 14mm | 20mm |
| 130 – 275        | 1000                       | 500  | 500  | 500  |
| 300 – 625        | 1000                       | 500  | 400  | 400  |